

### 双结嵌入式隔离器规格书

#### Dual Drop In Isolator Specification

产品型号	Part No.	DI070TA-D
工作频率	Frequency	960~1215 MHz
带 宽	Bandwidth	255 MHz
插入损耗	Insertion Loss	0.8dB max
反向隔离	Isolation	40dB min
驻 波 比	VSWR	1.2 max
通过功率	Forward Power	150W min
反射功率	Reverse Power	100W min
温度范围	Temperature	-20℃~+70℃
传输方向	Direction	Clockwise/Anticlockwise
连接方式	Connector Type	TAB
外型尺寸	Size	55.2*31.8*6 mm

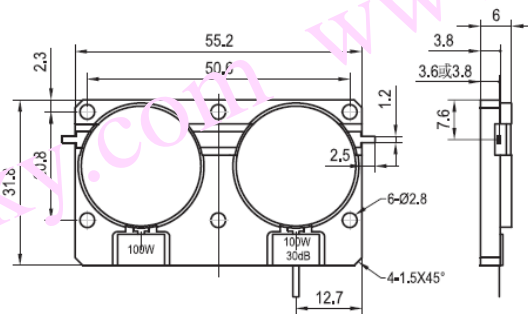

DI070TA-D 安装图