

双结嵌入式环行器规格书

Dual Drop In Circulator Specification

产品型号	Part No.	DC070SA-D
工作频率	Frequency	1700-1900 MHz
带 宽	Bandwidth	200 MHz
插入损耗	Insertion Loss	0.6dB max
反向隔离	Isolation	45dB min
驻 波 比	VSWR	1.2 max
通过功率	Forward Power	150W min
反射功率	Reverse Power	150W min
温度范围	Temperature	-40℃~+85℃
传输方向	Direction	Clockwise/Anticlockwise
连接方式	Connector Type	N or SMA
外型尺寸	Size	50.8*25.4*12 mm

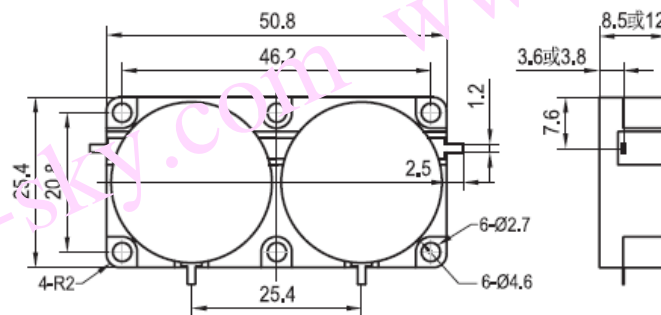

DC070SA-D 安装图