

嵌入式隔离器规格书

Drop In Isolator Specification

产品型号	Part No.	DI070SA
工作频率	Frequency	2200-2600 MHz
带 宽	BandWidth	400 MHz
插入损耗	Insertion Loss	0.4dB max
反向隔离	Isolation	20dB min
驻 波 比	VSWP	1.2 max
通过功率	Forward Power	150W min
反射功率	Reverse Power	100W min
温度范围	Temperature	-40℃~+85℃
传输方向	Direction	Clockwise/Anticlockwise
连接方式	Connector Type	TAB
外型尺寸	Size	25.4*31.8*12 mm

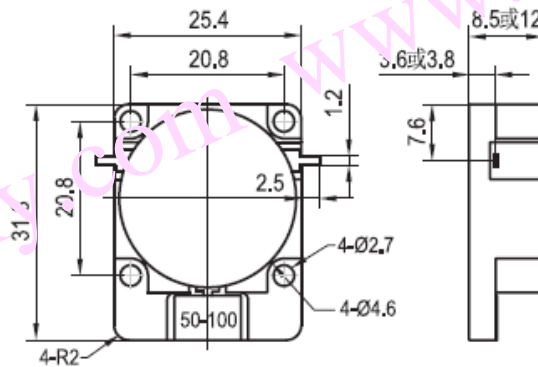

DI070SA 安装图