

嵌入式隔离器规格书

Drop In Isolator Specification

产品型号	Part No.	DI020PA
工作频率	Frequency	270-300 MHz
带 宽	BandWidth	30 MHz
插入损耗	Insertion Loss	0.3dB max
反向隔离	Isolation	20dB min
驻 波 比	VSWP	1.2 max
通过功率	Forward Power	200W min
反射功率	Reverse Power	100W (20dB) min
温度范围	Temperature	-20℃~+70℃
传输方向	Direction	Clockwise/Anticlockwise
连接方式	Connector Type	TAB
外型尺寸	Size	50.5*64.5*15 mm

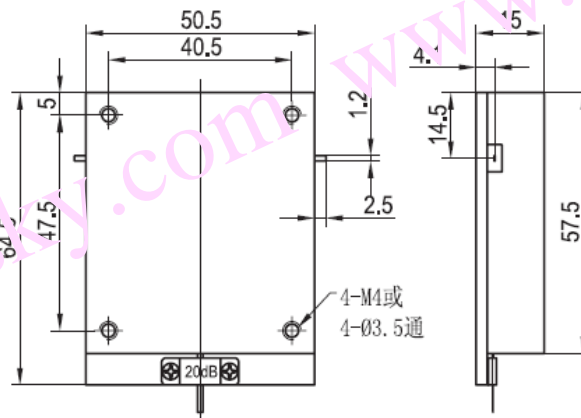

DI020PA 安装图