

嵌入式环行器规格书

Drop In Circulator Specification

产品型号	Part No.	DC130SA
工作频率	Frequency	1380-1450 MHz
带 宽	Bandwidth	70 MHz
插入损耗	Insertion Loss	0.3dB max
反向隔离	Isolation	20dB min
驻 波 比	VSWR	1.2 max
通过功率	Forward Power	100W min
反射功率	Reverse Power	100W min
温度范围	Temperature	-40℃~+85℃
传输方向	Direction	Clockwise/Anticlockwise
连接方式	Connector Type	TAB
外型尺寸	Size	19*19*8 mm

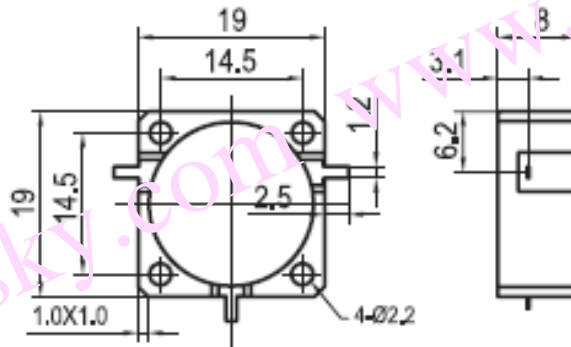

DC130SA 安装图