

## 嵌入式环行器规格书

### Drop In Circulator Specification

产品型号	Part No.	DC080SA
工作频率	Frequency	1900-2200 MHz
带 宽	Bandwidth	300 MHz
插入损耗	Insertion Loss	0.3dB max
反向隔离	Isolation	22dB min
驻 波 比	VSWR	1.2 max
通过功率	Forward Power	150W min
反射功率	Reverse Power	150W min
温度范围	Temperature	-40℃~+85℃
传输方向	Direction	Clockwise/Anticlockwise
连接方式	Connector Type	TAB
外型尺寸	Size	20*20*8.5 mm

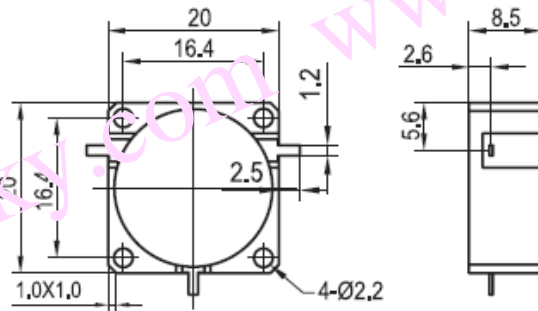

DC080SA 安装图