

嵌入式环行器规格书

Drop In Circulator Specification

产品型号	Part No.	DC020PA
工作频率	Frequency	270-300 MHz
带 宽	Bandwidth	30 MHz
插入损耗	Insertion Loss	0.3dB max
反向隔离	Isolation	20dB min
驻 波 比	VSWR	1.2 max
通过功率	Forward Power	300W min
反射功率	Reverse Power	300W min
温度范围	Temperature	-20℃~+70℃
传输方向	Direction	Clockwise/Anticlockwise
连接方式	Connector Type	TAB
外型尺寸	Size	50.5*57.5*15 mm

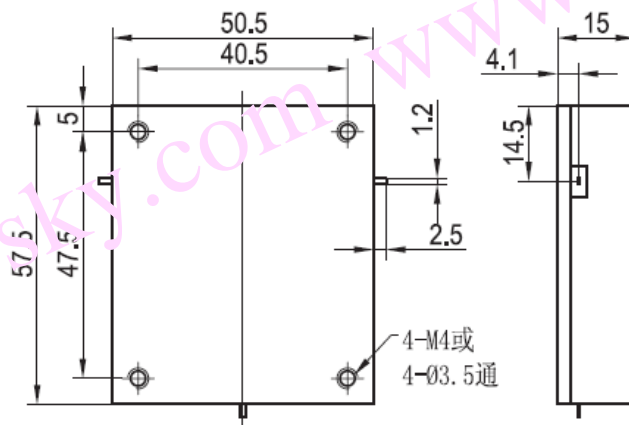

DC020PA 安装图