

## 同轴隔离器规格书

### Coaxial Isolator Specification

产品型号	Part No.	CI003PA
工作频率	Frequency	70-120 MHz
带 宽	BandWidth	10 MHz
插入损耗	Insertion Loss	0.6dB max
反向隔离	Isolation	20dB min
驻 波 比	VSWR	1.2 max
通过功率	Forward Power	100W min
反射功率	Reverse Power	100W min
温度范围	Temperature	-10°C~+65°C
传输方向	Direction	Clockwise/Anticlockwise
连接方式	Connector Type	SMA/N
外型尺寸	Size	80*80*28 mm

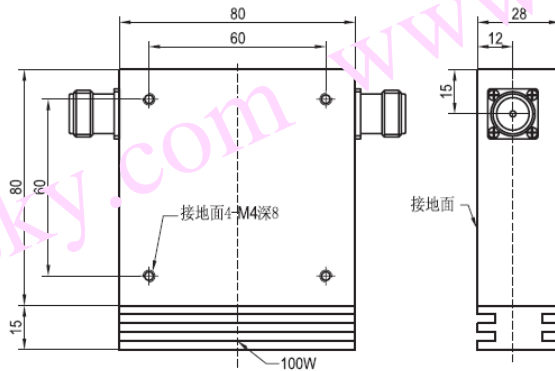

CI003PA 安装图