

同轴隔离器规格书

Coaxial Isolator Specification

产品型号	Part No.	CI003PA
工作频率	Frequency	56-86 MHz
带 宽	BandWidth	30 MHz
插入损耗	Insertion Loss	1.2dB max
反向隔离	Isolation	18dB min
驻 波 比	VSWR	1.3 max
通过功率	Forward Power	100W min
反射功率	Reverse Power	100W min
温度范围	Temperature	-10°C~+65°C
传输方向	Direction	Clockwise/Anticlockwise
连接方式	Connector Type	SMA/N
外型尺寸	Size	80*80*28 mm

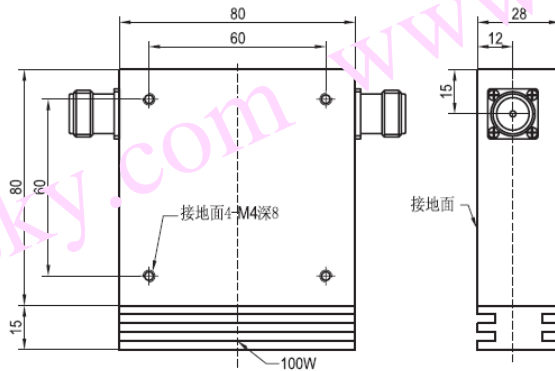

CI003PA 安装图