

宽带隔离器规格书

Broadband Isolator Specification

产品型号	Part No.	B1800PA
工作频率	Frequency	8~12 GHz
带 宽	BandWidth	4 GHz
插入损耗	Insertion Loss	0.5dB max
反向隔离	Isolation	20dB min
驻 波 比	VSWR	1.25 max
通过功率	Forward Power	10W min
反射功率	Reverse Power	10W min
温度范围	Temperature	-30℃~+70℃
传输方向	Direction	Clockwise/Anticlockwise
连接方式	Connector Type	SMA
外型尺寸	Size	12*20*13 mm

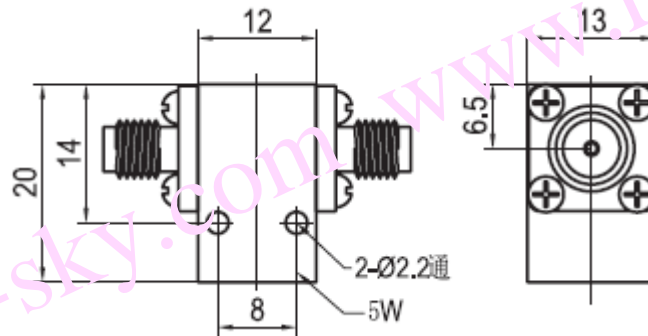

www.rf-sky.com

