

## 宽带环行器规格书

### Broadband Circulator Specification

产品型号	Part No.	BC600PA
工作频率	Frequency	6~12 GHz
带 宽	BandWidth	6 GHz
插入损耗	Insertion Loss	0.6dB max
反向隔离	Isolation	16dB min
驻 波 比	VSWR	1.4 max
通过功率	Forward Power	10W min
反射功率	Reverse Power	10W min
温度范围	Temperature	-30℃~+70℃
传输方向	Direction	Clockwise/Anticlockwise
连接方式	Connector Type	SMA
外型尺寸	Size	16*21*13 mm

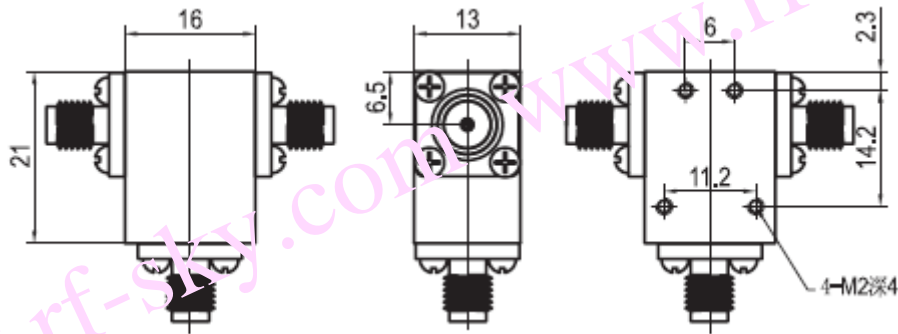

www.rf-sky.com

