

宽带环行器规格书

Broadband Circulator Specification

产品型号	Part No.	BC030PA
工作频率	Frequency	400-500 MHz
带 宽	BandWidth	100 MHz
插入损耗	Insertion Loss	0.5dB max
反向隔离	Isolation	20dB min
驻 波 比	VSWR	1.25 max
通过功率	Forward Power	200W min
反射功率	Reverse Power	200W min
温度范围	Temperature	-30℃~+75℃
传输方向	Direction	Clockwise/Anticlockwise
连接方式	Connector Type	SMA/N
外型尺寸	Size	48*48.2*24 mm

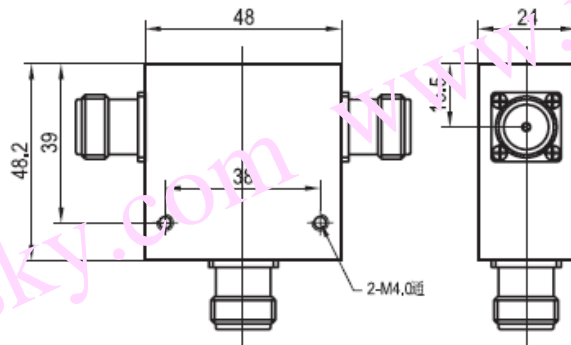

www.rf-sky.com

